



# SBL2045CF5H

## SCHOTTKY BARRIER RECTIFIER

Reverse Voltage - 45 Volts

Forward Current - 20 Amperes



### ITO-220AB

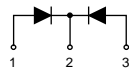
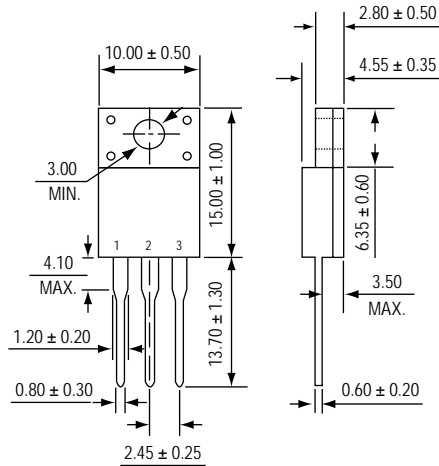

\*Dimensions in millimeters

### FEATURES

- \* Halogen-free type
- \* Compliance to RoHS product
- \* Low power loss & high efficiency
- \* High surge capability
- \* 20 Amperes total (10 Amperes per diode leg)
- \* High surge current capability
- \* Epitaxial construction
- \* Plastic Material-UL Recognition Flammability Classification 94V-0

### MECHANICAL DATA

**Case :** JEDEC ITO-220AB molded plastic body

**Terminals :** Plated Leads, solderable per MIL-STD-750, Method 2026

**Polarity :** Molded on body

**Mounting Position :** Any

### MAXIMUM RATINGS AND ELECTRICAL CHARACTERISTICS

Ratings at 25 °C ambient temperature unless otherwise specified.	SYMBOLS	SBL2045CF5H	UNITS
Maximum repetitive peak reverse voltage	VRRM	45	Volts
Maximum RMS voltage	VRMS	32	
Maximum DC blocking voltage	VDC	45	
Maximum average forward rectified current	I (AV)	20	Amps
Peak repetitive forward current (rated VR, square wave, 20KHz)	IFM	20	Amps
Peak forward surge current 8.3ms single half sine-wave superimposed on rated load (JEDEC Method)	IFSM	200	Amps
Maximum instantaneous forward voltage @ IF= 10 A	VF	Tj=25°C 0.55 Tj=125°C 0.50	Volts
Maximum DC reverse current at rated DC blocking voltage	IR	@Tj=25°C 0.5 @Tj=125°C 50	mA
Typical junction capacitance (Note)	CJ	400	pF
Typical thermal resistance	R JA	75	/ W
Operating junction temperature	TJ	125	
Storage temperature range	TSTG	-55 to +150	

Note : Measured at 1.0MHz and applied reverse voltage of 4.0V.

# RATINGS AND CHARACTERISTIC CURVES OF SBL2045CF5H

FIG. 1 - FORWARD CURRENT DERATING CURVE

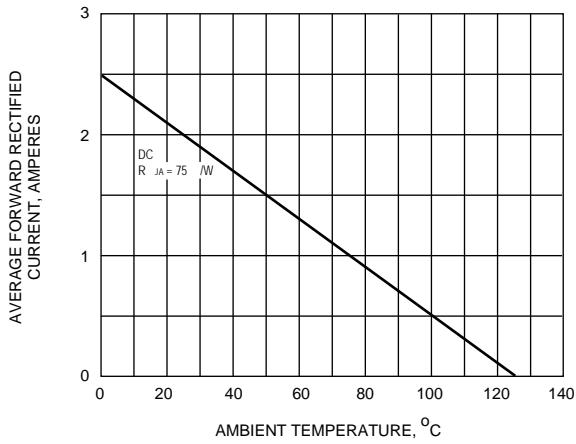

FIG. 2 - MAXIMUM NON-REPETITIVE PEAK FORWARD SURGE CURRENT

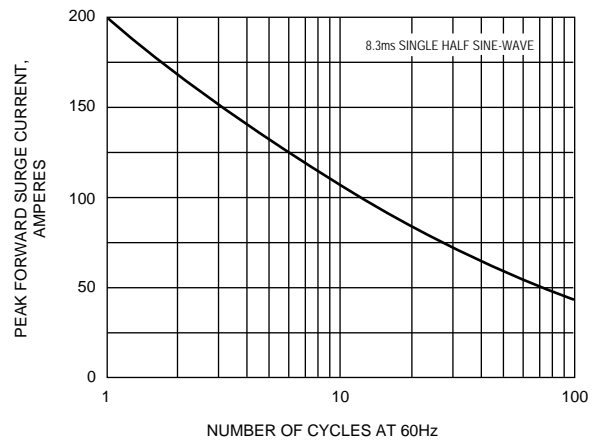

FIG. 3 - TYPICAL INSTANTANEOUS FORWARD CHARACTERISTICS

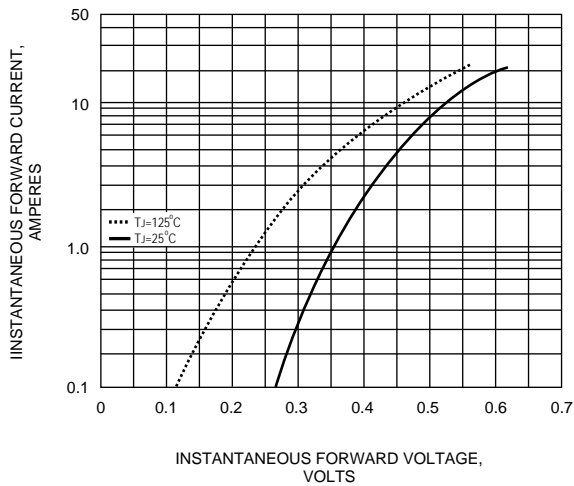

FIG. 4 - TYPICAL REVERSE CHARACTERISTICS

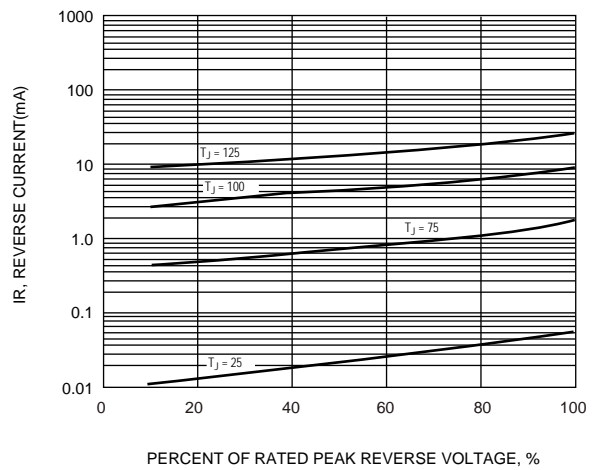
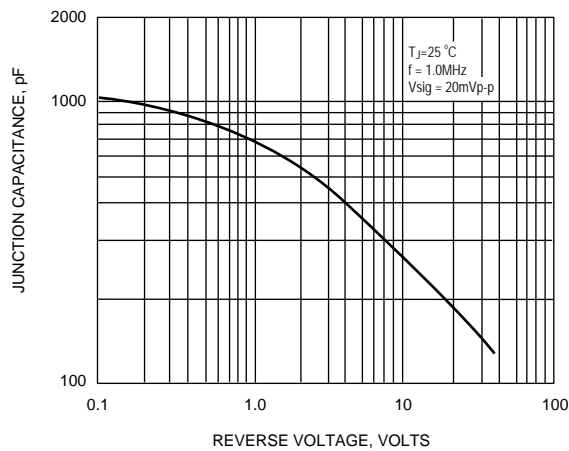

FIG. 5 - TYPICAL JUNCTION CAPACITANCE



**PACKING INFORMATION**

<b>Package</b>	<b>Packing Qty.</b>			<b>Inner Box Size (mm)</b>	<b>Carton Size (mm)</b>
	<b>Tube (pcs)</b>	<b>Inner box (kpcs)</b>	<b>Carton (kpcs)</b>		
ITO-220AB	50	4	8	570 x 147 x 150	585 x 316 x 164